

## 3" | Standard LED | Single Lamp

Change trims, optics, and lenses without skipping a beat. Our Opus™ luminaires are an engineering masterpiece. make changes as quickly as; a-one, and a-two, and a-three.

### FIXED

### ADJUSTABLE

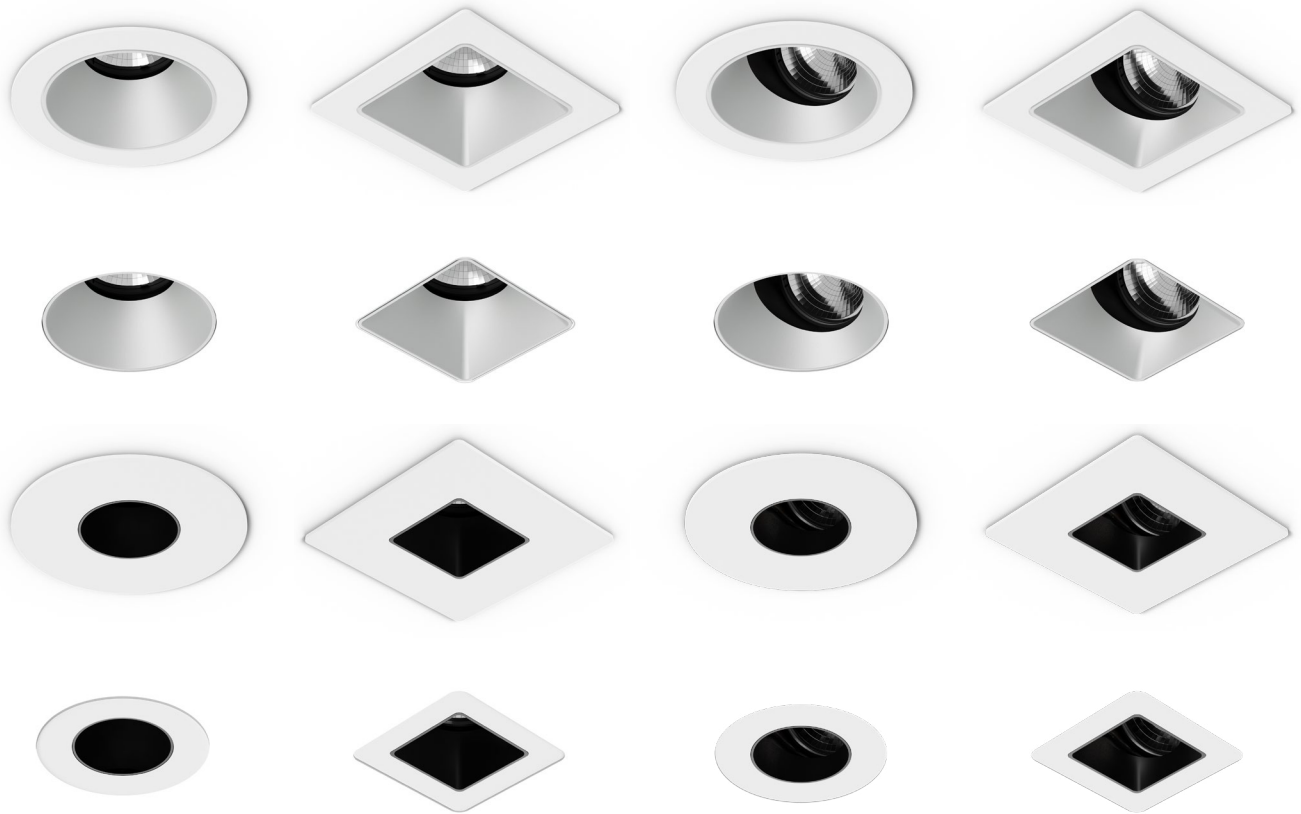

### WALL WASH



### DECORATIVE



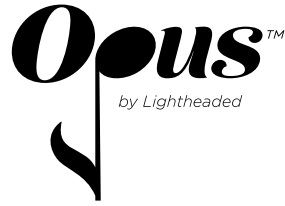

## 3" | Standard LED | Multiples

Change trims, optics, and lenses without skipping a beat. Our Opus™ luminaires are an engineering masterpiece. make changes as quickly as; a-one, and a-two, and a-three.

### FIXED

### ADJUSTABLE

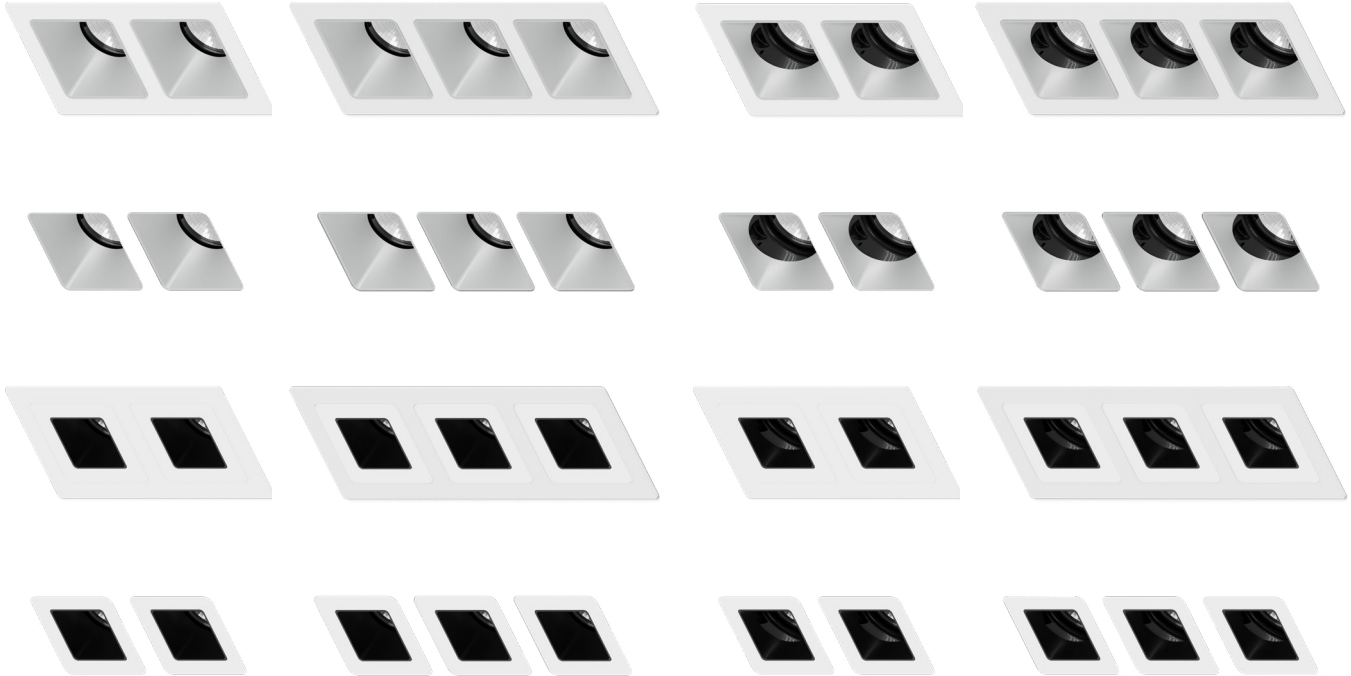

### WALL WASH



### RATINGS



California  
Title 24 JA8



Warm  
Dimming



Damp  
Location



Wet  
Location

### CERTIFICATIONS



5yr. Warranty

# OPUS™

## 3" | Standard LED

### FEATURES

- 3" Aperture (Fixed, Adjustable and Wall Wash)
- 2" Aperture (Pinholes)
- Trimmed, Trimless and Wood Trimless options
- Single or multiple lamp options
- 40° Vertical tilt (adjustable trims)
- 361° Rotation (adjustable trims)
- Powder coated trim finishes
- Damp location listed, wet location optional
- Two piece and single piece trims are available w/optional regressed aperture glass lens
- Media holder and clear lens standard with open trim option, optional media available
- Flag style mounting feet, designed for up to 1.25" ceiling thickness standard
- Anodized gold heat sink
- Static CCT and warm dimming available
- Lutron Athena Wireless Node available. Enables individual wireless fixture control.
- Rated for insulated ceilings to a maximum ambient temperature of 40°C (104°F)
- Rated for non-insulated ceilings to a maximum ambient temperature of 45°C (113°F)

### FLANGE & REFLECTOR FINISHES

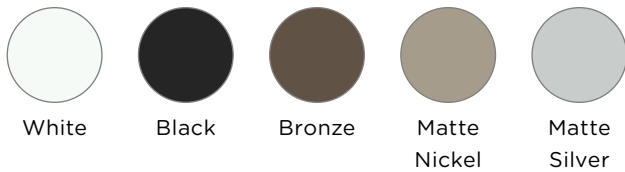

### COLOR TEMPERATURES

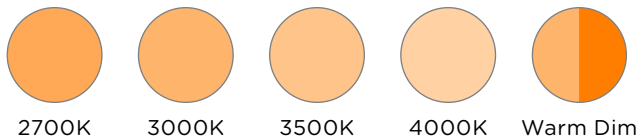

### BEAM SPREADS

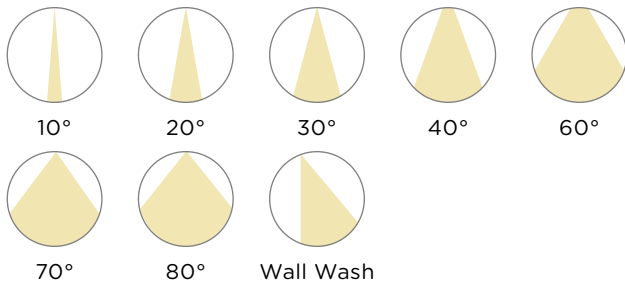

### PERFORMANCE SUMMARY (PER LAMP)

Color Accuracy (SDCM)	<3	
L70 Estimate (h)	50,000	
Color Rendering (CRI)	80	90
Lumen Series	8010	9008
Source Lumens	1270	1070
Delivered Lumens	1025	875
LED Wattage	9	9
Lumen Series	8014	9010
Source Lumens	1755	1500
Delivered Lumens	1450	1225
LED Wattage	13	13
Lumen Series	8018	9014
Source Lumens	2450	2075
Delivered Lumens	1975	1675
LED Wattage	18	18
Lumen Series	8023	9018
Source Lumens	3275	2750
Delivered Lumens	2625	2225
LED Wattage	25	25
Lumen Series	8030	9023
Source Lumens	4200	3500
Delivered Lumens	3300	2850
LED Wattage	33	33

### PERFORMANCE SUMMARY (PER LAMP)—WARM DIMMING

Color Accuracy (SDCM)	<3	
L70 Estimate (h)	50,000	
Color Rendering (CRI)	95	
Lumen Series	9510	
Source Lumens	1000	
Delivered Lumens	925	
LED Wattage	12	

- Source lumens are based on 3000K color temperature.
- Delivered lumens are based on 3000K color temperature, 40° beam angle and no lens.
- Source & delivered lumens do not apply to 10° beam.
- Refer to IES files for individual product information
- Consult factory for additional lower lumen options.

### WARM DIMMING METRICS

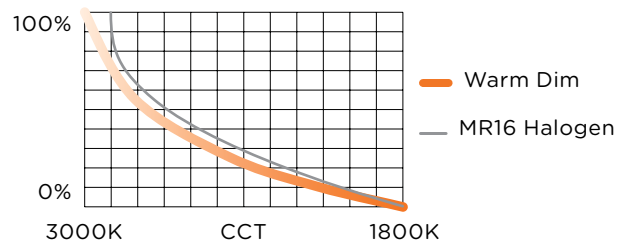

### PRODUCT NOTES:

- Pinhole reflector finish painted 04 black standard.
- TL flange type does not require flange finish for RF, RA, SF and SA trims.
- CC custom color requires factory consultation.
- 00 Flange and reflector are a single piece and painted one color. Only available with trimmed flange type with RF, RA, SF and SA trims types.
- GSL & GFRO glass lens are attached to the regressed trim aperture.
- GWV wall wash & BWW Wall Wash must be ordered together and are only available with RA and SA trim types.
- Field interchangeable beam spread options require consultation with Lighthouse personnel.
- B10 (10° Beam) is only available with 8010, 9008, 8014 and 9010.
- 8030 and 9023 are only available S and P dimming.
- S dimming is only available in 120 voltage.
- D dimming is not available with TL trimless flange with 8023, 9018, 8030 & 9023 lumen series.
- P1 dimming is not available with TL trimless flange.
- LH dimming is not available 8023, 9018, 8030 and 9023 with TL (trimless) ceiling type.
- 347V is only available in P (0-10V) dimming and T (trimmed) flange types.
- Athena Wireless node is only in P (0-10V) and D (Dali 2) dimming with T (trimmed) flange type.
- Athena Wireless node is only available in F (non-insulated) housing type.
- Media holder and media are only available with OPEN lens option. Comes standard with clear lens, optional media replaces clear lens when selected.
- A1 Decorative acrylic lens is only available with RF & SF fixed trims, T (trimmed) flange & 00 single piece flange finish.
- Housing can be ordered and shipped prior to luminaire.
- IC & CP are not available for with 8030, 8023, 9023 or 9018 Lumens Series.
- Round & Square trim types utilize the same ceiling cutout shape.
- Wet Location
- 3000K-1800K Warm Dimming only available in 9510
- Title 24 JA8 qualified, consult factory for complete listing

### SELECT A TRIM

#### [1] TRIM

- T3RA** Round Adjustable ●
- T3RF** Round Fixed ●
- T3RP** Round Pinhole Fixed<sup>1</sup>
- T3RPA** Round Pinhole Adjustable<sup>1</sup>
- T3SA** Square Adjustable ●
- T3SF** Square Fixed ●
- T3SP** Square Pinhole Fixed<sup>1</sup>
- T3SPA** Square Pinhole Adjustable<sup>1</sup>

#### [2] FLANGE TYPE

- T** Trimmed
- TL** Trimless<sup>2</sup>

#### [3] FLANGE FINISH

- 01** White
- 04** Black
- 05** Matte Silver
- 06** Bronze
- 11** Matte Nickel
- CC** Custom Color<sup>3</sup>
- [Blank]** No Flange Finish<sup>2</sup>

#### [4] REFLECTOR FINISH

- 00** Single Piece Flange<sup>4</sup>
- 01** White
- 04** Black
- 05** Matte Silver
- 06** Bronze
- 11** Matte Nickel
- CC** Custom Color<sup>3</sup>

#### [↓] EXCLUDES RP, RPA, SP, SPA TRIMS

- [Blank]** No Reflector Finish

#### [5] GLASS (MOUNTED TO TRIM)

- OPEN** No Lens
- GSL** Softening ●<sup>5</sup>
- GFRO** Frosted ●<sup>5</sup>

#### [↓] RA, SA TRIMS ONLY

- GWV** Wall Wash ●<sup>6</sup>

#### [6] MODULE & BEAM SPREAD<sup>7</sup>

- B10** 10° Beam<sup>8</sup>
- B20** 20° Beam
- B30** 30° Beam
- B40** 40° Beam
- B60** 60° Beam
- B70** 70° Beam
- B80** 80° Beam

#### [↓] RA, SA TRIMS ONLY

- BWW** Wall Wash<sup>6</sup>

#### [7] COLOR TEMPERATURE

- 27** 2700K
- 30** 3000K
- 35** 3500K
- 40** 4000K
- 3018** 3000K-1800K ●

#### [8] LUMEN SERIES

- 8010** 80 CRI, 1270lm
- 9008** 90 CRI, 1070lm ●
- 8014** 80 CRI, 1775lm
- 9010** 90 CRI, 1500lm ●
- 8018** 80 CRI, 2450lm
- 9014** 90 CRI, 2075lm ●
- 8023** 80 CRI, 3275lm
- 9018** 90 CRI, 2750lm
- 8030** 80 CRI, 4200lm<sup>9</sup>
- 9023** 90 CRI, 3500lm<sup>9</sup>
- 9510** 95 CRI, 925lm ●●

#### [9] DIMMING

- S** Phase Dimming (1%)<sup>10</sup>
- P** 0-10V (1%)
- D** Dali-2 (1%)<sup>11</sup>
- P1** eldoLED 0-10V Dimming (1%)<sup>12</sup>

- LH** Lutron Hi-lume EcoSystem Soft-on Fade-to-Black (1%)<sup>13</sup>

#### [10] VOLTAGE

- 120** 120V
- 277** 277V
- 347** 347V<sup>14</sup>

#### [11] OPTIONS

- [Blank]** No options
- AW** Lutron Athena Wireless Node RF only<sup>15,16</sup>

#### [12] OPTIONAL MEDIA (1 MAX)<sup>17</sup>

#### [↓] MOUNTED TO LIGHT ENGINE

- [Blank]** Clear
- SL** Softening
- FRO** Frosted
- HC** Honeycomb
- SPDL** Spread

#### [13] OPTIONAL ACCESSORIES

- [Blank]** no option
- A1** Decorative frosted acrylic lens - 1.5"<sup>18</sup>

### SELECT A HOUSING

#### [14] HOUSING

- R3P** 3" Baseplate<sup>19</sup>

#### [15] CEILING

- F** Non-Insulated
- IC** Insulated Airtight ●<sup>20</sup>
- CP** Chicago Plenum<sup>20</sup>

#### [16] TRIM SHAPE

- R** Round<sup>21</sup>

#### [17] FLANGE TYPE

- T** Trimmed & Trimless

### PRODUCT NOTES:

- See table for tilt information
- Pinhole aperture finish painted O4 black standard.
- CC custom color requires factory consultation.
- GSL & GFRO glass lens are attached to the regressed trim aperture.
- GWW wall wash & BWW Wall Wash must be ordered together and are only available with RA and SA trim types.
- Round wall wash is only functional between 1/2" & 1-1/4" thick ceiling. Unavailable after 1-1/4" thick ceiling.
- Square wall wash is only functional between 1/2" & 3/4" thick ceiling. Unavailable after 3/4" thick ceiling.
- Field interchangeable beam spread options require consultation with Lighthheaded personnel.
- B10 (10° Beam) is only available with 8010, 9008, 8014 and 9010.
- 8030 and 9023 are only available S and P dimming.
- S dimming is only available in 120 voltage.
- D dimming is not available with with 8023, 9018, 8030 & 9023 lumen series.
- LH dimming is not available with 8023, 9018, 8030 and 9023 lumen series
- Media holder and media are only available with OPEN lens option. Comes standard with clear lens, optional media replaces clear lens when selected.
- Housing can be ordered and shipped prior to luminaire.
- IC & CP are not available for with 8030, 8023, 9023 or 9018 Lumen Series.
  - 3000K-1800K Warm Dimming only available in 9510
  - Title 24 JA8 qualified, consult factory for complete listing

### SELECT A TRIM

#### [1] TRIM

- T3RA** Round Adjustable<sup>1</sup>
- T3RF** Round Fixed ●
- T3RP** Round Pinhole Fixed<sup>2</sup>
- T3RPA** Round Pinhole Adjustable<sup>1,2</sup>
- T3SA** Square Adjustable<sup>1</sup>
- T3SF** Square Fixed ●
- T3SP** Square Pinhole Fixed<sup>2</sup>
- T3SPA** Square Pinhole Adjustable<sup>1,2</sup>

#### [2] FLANGE TYPE

- TLW** Wood Trimless

#### [3] FINISH

- 01** White
- 04** Black
- 05** Matte Silver
- 06** Bronze
- 11** Matte Nickel
- CC** Custom Color<sup>3</sup>

#### [4] GLASS (MOUNTED TO TRIM)

- OPEN** No Lens
- GSL** Softening ●<sup>4</sup>
- GFRO** Frosted ●<sup>4</sup>

#### [↓] RA, SA TRIMS ONLY

- GWW** Wall Wash ●<sup>5, 6, 7</sup>

#### [5] MODULE & BEAM SPREAD<sup>8</sup>

- B10** 10° Beam<sup>9</sup>
- B20** 20° Beam
- B30** 30° Beam
- B40** 40° Beam
- B60** 60° Beam
- B70** 70° Beam
- B80** 80° Beam

#### [↓] RA, SA TRIMS ONLY

- BWW** Wall Wash<sup>5</sup>

### [6] COLOR TEMPERATURE

- 27** 2700K
- 30** 3000K
- 35** 3500K
- 40** 4000K
- 3018** 3000K-1800K ●

### [7] LUMEN SERIES

- 8010** 80 CRI, 1270lm
- 9008** 90 CRI, 1070lm ●
- 8014** 80 CRI, 1775lm
- 9010** 90 CRI, 1500lm ●
- 8018** 80 CRI, 2450lm
- 9014** 90 CRI, 2075lm ●
- 8023** 80 CRI, 3275lm
- 9018** 90 CRI, 2750lm
- 8030** 80 CRI, 4200lm<sup>10</sup>
- 9023** 90 CRI, 3500lm<sup>10</sup>
- 9510** 95 CRI, 925lm ● ●

### [8] DIMMING

- S** Phase Dimming (1%)<sup>11</sup>
- P** 0-10V (1%)
- D** Dali-2 (1%)<sup>12</sup>
- LH** Lutron Hi-lume EcoSystem Soft-on Fade-to-Black (1%)<sup>13</sup>

### [9] VOLTAGE

- 120** 120V
- 277** 277V

### [10] CEILING THICKNESS

- 1** 0.5" to 0.75" Ceiling thickness<sup>1</sup>
- 2** 0.75" to 1.0" Ceiling thickness<sup>1</sup>
- 3** 1.0" to 1.25" Ceiling thickness<sup>1</sup>
- 4** 1.25" to 2.5" Ceiling thickness<sup>1</sup>

### [11] OPTIONAL MEDIA (1 MAX)<sup>14</sup>

#### [↓] MOUNTED TO LIGHT ENGINE

- [Blank]** Clear
- SL** Softening
- FRO** Frosted
- HC** Honeycomb
- SPDL** Spread

### SELECT A HOUSING

#### [12] HOUSING

- R3P** 3" Baseplate<sup>15</sup>

#### [13] CEILING

- F** Non-Insulated
- IC** Insulated Airtight ●<sup>16</sup>
- CP** Chicago Plenum<sup>16</sup>

#### [14] TRIM SHAPE

- R** Round
- S** Square

#### [15] FLANGE TYPE

- TLW** Wood Trimless

Order Code Example: T3SA-2T-01-04-GSL-B20-27-8014-S-120-R3P-F-S-2-T

### PRODUCT NOTES:

1. Consult factory for additional combinations.
2. Pinhole reflector finish painted O4 black standard.
3. Trim layout must match housing layout.
4. TL flange type does not require flange finish for SF and SA trims.
5. CC custom color requires factory consultation.
6. GSL & GFRO glass lens are attached to the regressed trim aperture.
7. GWW wall wash & BWW Wall Wash must be ordered together and are only available with SA trim type.
8. Field interchangeable beam spread options require consultation with Lighthheaded personnel.
9. B10 (10° Beam) is only available with 8010, 9008, 8014 and 9010.
10. S dimming is only available in 120 voltage.
11. P1 dimming is not available with TL trimless flange
12. 347V is only available in P (0-10V) dimming and T (trimmed) flange types.
13. Media holder and media are only available with OPEN lens option. Comes standard with clear lens, optional media replaces clear lens when selected.
14. Housing can be ordered and shipped prior to luminaire.
  - Wet Location
  - 3000K-1800K Warm Dimming only available in 9510

### SELECT A TRIM

#### [1] TRIM<sup>1</sup>

- T3SA** Square Adjustable
- T3SF** Square Fixed
- T3SP** Square Pinhole Fixed<sup>2</sup>
- T3SPA** Square Pinhole Adjustable<sup>2</sup>

#### [2] LAYOUT<sup>3</sup>

- 2** 1x2 Multiple
- 3** 1x3 Multiple

#### [3] FLANGE TYPE

- T** Trimmed
- TL** Trimless<sup>4</sup>

#### [4] FLANGE FINISH

- 01** White
- 04** Black
- 05** Matte Silver
- 06** Bronze
- 11** Matte Nickel
- CC** Custom Color<sup>5</sup>
- [Blank]** No Flange Finish<sup>4</sup>

#### [5] REFLECTOR FINISH

- 01** White
- 04** Black
- 05** Matte Silver
- 06** Bronze
- 11** Matte Nickel
- CC** Custom Color<sup>5</sup>

#### [↓] EXCLUDES SP, SPA TRIMS

- [Blank]** No Reflector Finish

#### [6] GLASS (MOUNTED TO TRIM)

- OPEN** No Lens
- GSL** Softening ●<sup>6</sup>
- GFRO** Frosted ●<sup>6</sup>

#### [↓] SA TRIMS ONLY

- GWW** Wall Wash ●<sup>7</sup>

#### [7] MODULE & BEAM SPREAD<sup>8</sup>

- B10** 10° Beam<sup>9</sup>
- B20** 20° Beam
- B30** 30° Beam
- B40** 40° Beam
- B60** 60° Beam
- B70** 70° Beam
- B80** 80° Beam

#### [↓] SA TRIMS ONLY

- BWW** Wall Wash<sup>7</sup>

#### [8] COLOR TEMPERATURE

- 27** 2700K
- 30** 3000K
- 35** 3500K
- 40** 4000K
- 3018** 3000K-1800K ●

#### [9] LUMEN SERIES

- 8010** 80 CRI, 1270lm
- 9008** 90 CRI, 1070lm
- 8014** 80 CRI, 1775lm
- 9010** 90 CRI, 1500lm
- 8018** 80 CRI, 2450lm
- 9014** 90 CRI, 2075lm
- 9510** 95 CRI, 925lm ●

#### [10] DIMMING

- S** Phase Dimming (1%)<sup>10</sup>
- P** 0-10V (1%)
- D** Dali-2 (1%)
- P1** eldoLED 0-10V Dimming (1%)<sup>11</sup>
- LH** Lutron Hi-lume EcoSystem Soft-on Fade-to-Black (1%)

#### [11] VOLTAGE

- 120** 120V
- 277** 277V
- 347** 347V<sup>12</sup>

#### [12] OPTIONAL MEDIA (1 MAX)<sup>13</sup>

#### [↓] MOUNTED TO LIGHT ENGINE

- [Blank]** Clear
- SL** Softening
- FRO** Frosted
- HC** Honeycomb
- SPDL** Spread

### SELECT A HOUSING

#### [13] HOUSING

- R3P** 3" Baseplate<sup>14</sup>

#### [14] CEILING

- F** Non-Insulated

#### [15] TRIM SHAPE

- S** Square

#### [16] LAYOUT<sup>5</sup>

- 2** 1x2 Multiple
- 3** 1x3 Multiple

#### [17] FLANGE TYPE

- T** Trimmed & Trimless

**ROUND SINGLE TRIM DIMENSIONS**

**FIXED**

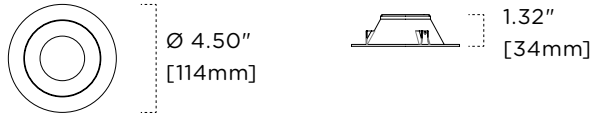

**TRIMLESS/WOOD TRIMLESS FIXED**



**ADJUSTABLE**

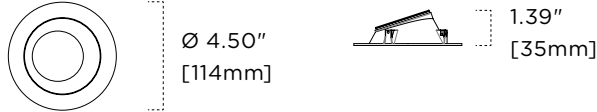

**TRIMLESS/WOOD TRIMLESS ADJUSTABLE**

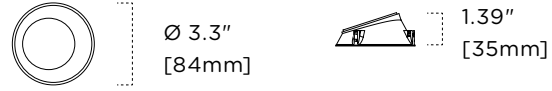

**PINHOLE**

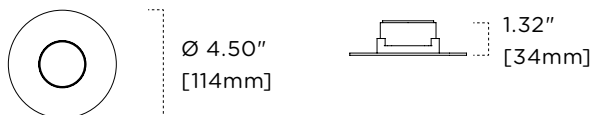

**TRIMLESS/WOOD TRIMLESS PINHOLE**



**PINHOLE ADJUSTABLE**

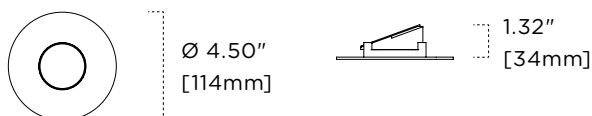

**TRIMLESS/WOOD TRIMLESS PINHOLE ADJUSTABLE**



**DECORATIVE**

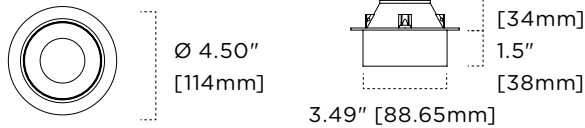

**QUARE SINGLE TRIM DIMENSIONS**

**FIXED**

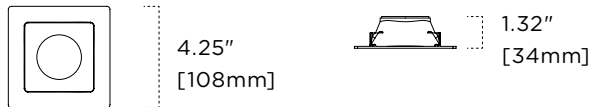

**TRIMLESS/WOOD TRIMLESS FIXED**



**ADJUSTABLE TRIM**

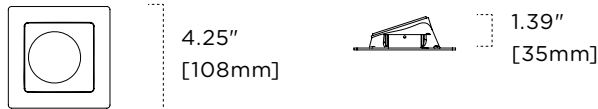

**TRIMLESS/WOOD TRIMLESS ADJUSTABLE**



**PINHOLE**

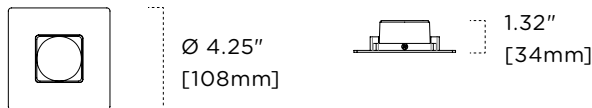

**TRIMLESS/WOOD TRIMLESS PINHOLE**

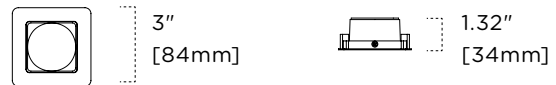

**PINHOLE ADJUSTABLE**

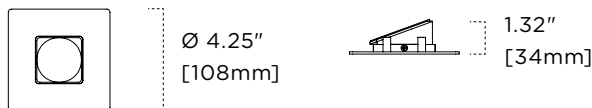

**TRIMLESS/WOOD TRIMLESS PINHOLE ADJUSTABLE**

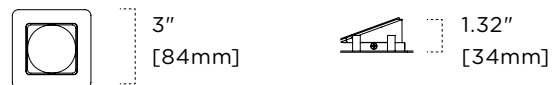



**SQUARE SINGLE TRIM DIMENSIONS (CONTINUED)**

**DECORATIVE**

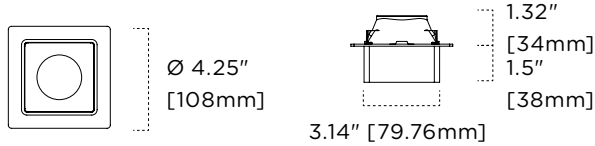

**1X2 MULTIPLE DIMENSIONS**

**ADJUSTABLE**

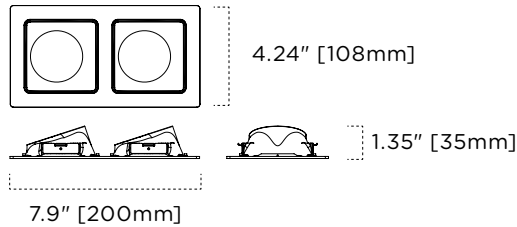

**FIXED**

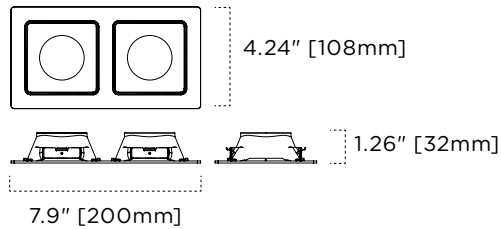

**ADJUSTABLE PINHOLE**

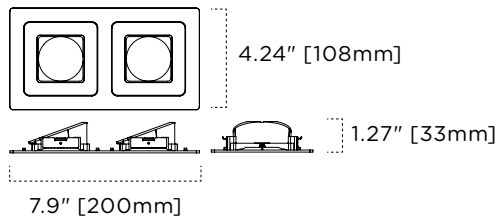

**FIXED PINHOLE**

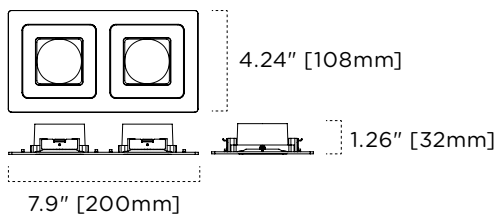

**1X2 TRIMLESS MULTIPLE DIMENSIONS**

**ADJUSTABLE**

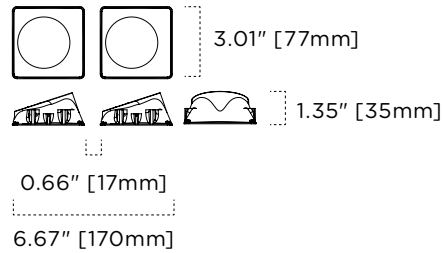

**FIXED**

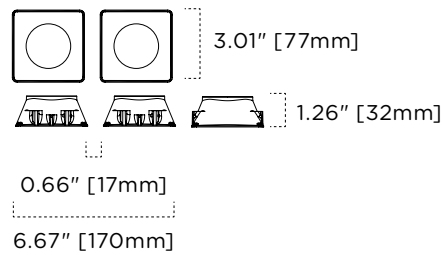

**ADJUSTABLE PINHOLE**

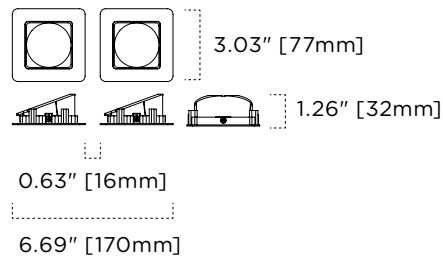

**FIXED PINHOLE**

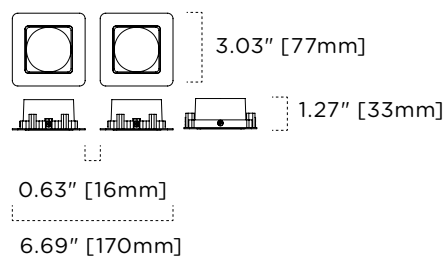



## 1X3 MULTIPLE DIMENSIONS

### ADJUSTABLE

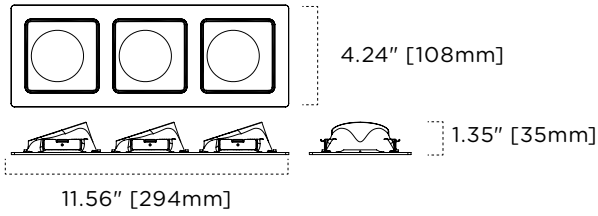

### FIXED

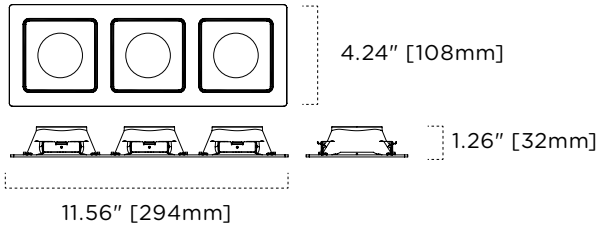

### ADJUSTABLE PINHOLE

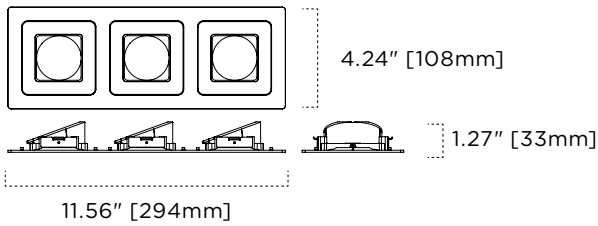

### FIXED PINHOLE

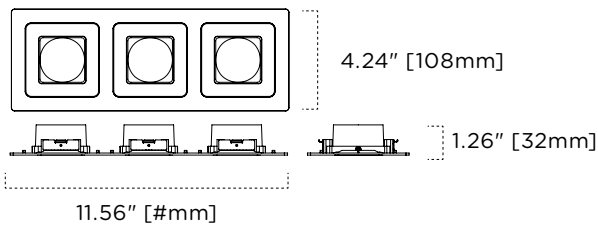

## 1X3 TRIMLESS MULTIPLE DIMENSIONS

### ADJUSTABLE

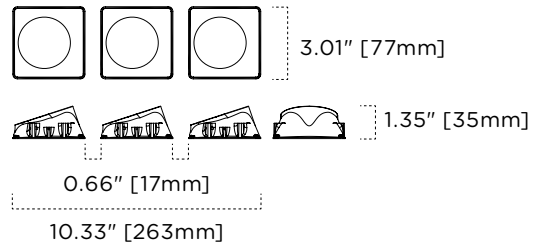

### FIXED

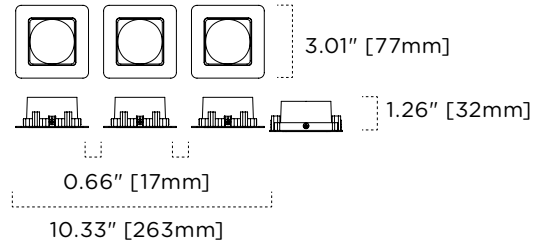

### ADJUSTABLE PINHOLE

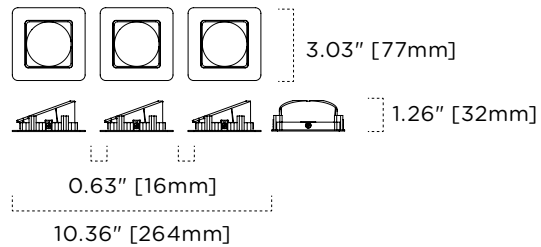

### FIXED PINHOLE

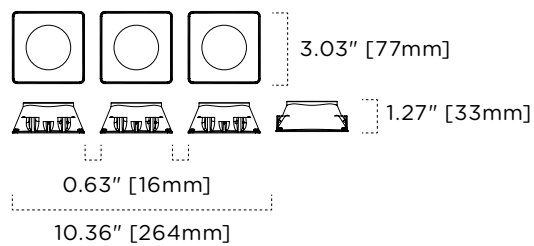

## CEILING CUTOUTS

### TRIMMED /TRIMLESS ROUND

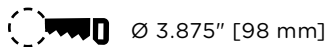

### WOOD TRIMLESS ROUND

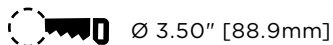

### TRIMMED /TRIMLESS SQUARE

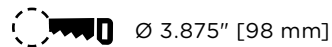

### WOOD TRIMLESS SQUARE

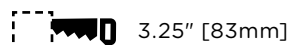

## LIGHT ENGINE DIMENSIONS

### FIXED TRIM & TRIMLESS

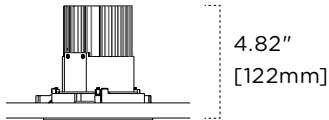

### ADJUSTABLE TRIM & TRIMLESS

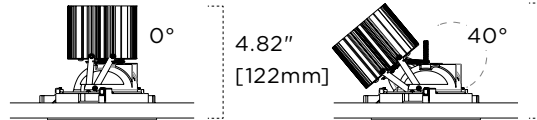

### WALL WASH TRIM & TRIMLESS

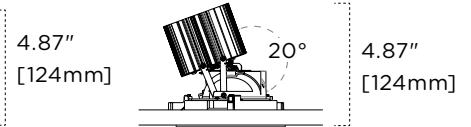

### FIXED WOOD TRIMLESS

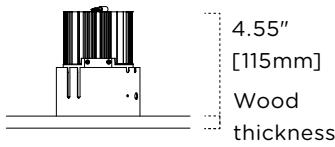

### ADJUSTABLE WOOD TRIMLESS

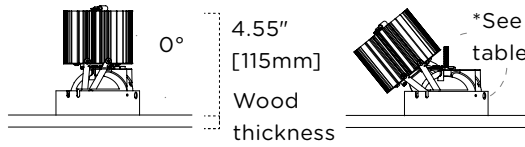

### WALL WASH WOOD TRIMLESS

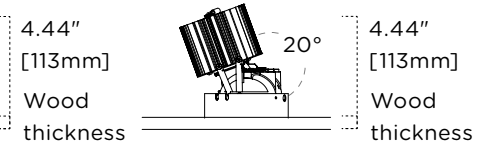

## ADJUSTABLE ROUND/SQUARE WOOD TRIMLESS VARIANCES ON TILT WITH WOOD CEILING THICKNESS

Ceiling thickness (Inches)	Round Maximum tilt (Degree)	Sqaure Maximum tilt (Degree)
0.50	30	20
0.75	30	20
1.00	24	15
1.25	20	13
1.50	10	9
1.75	9	9
2.0	9	9
2.25	8	9
2.5	7	9

## REMODEL DRIVER DIMENSIONS

Minimum Required Plenum Height 5.5" [140mm]

### TRIMMED REMODEL DRIVER

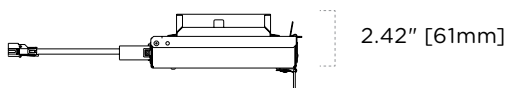
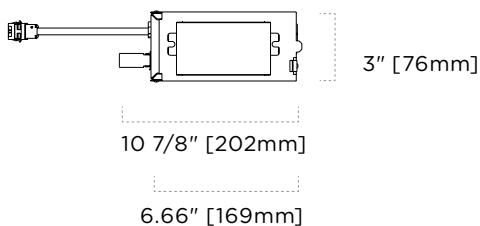

### TRIMLESS / WOOD TRIMLESS REMODEL DRIVER

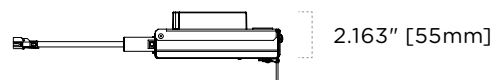
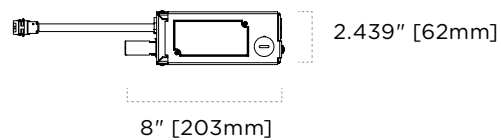

**NON-INSULATED (F)—ROUND & SQUARE SINGLE TRIM HOUSING DIMENSIONS**

**TRIMMED / TRIMLESS**

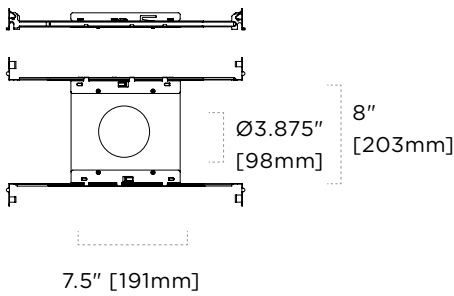

**ROUND WOOD TRIMLESS**

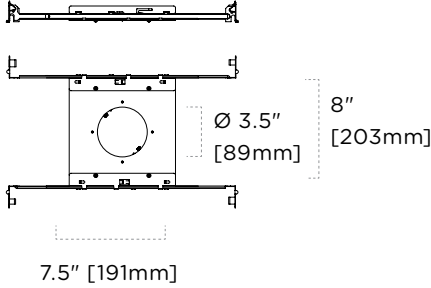

**SQUARE WOOD TRIMLESS**

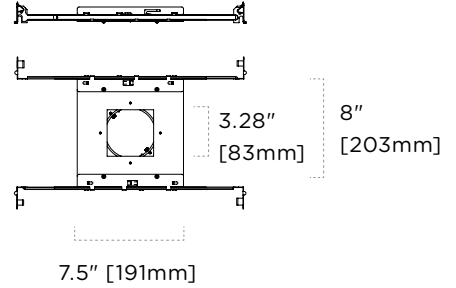

**NON-INSULATED (F)—ROUND & SQUARE MULTIPLES TRIM HOUSING DIMENSIONS**

**TRIMMED / TRIMLESS (1X2)**

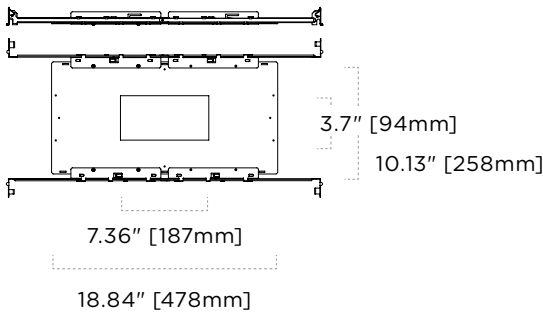

**TRIMMED / TRIMLESS (1X3)**

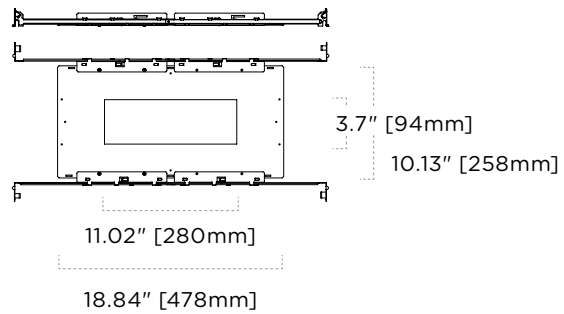

**INSULATED AIRTIGHT (IC)—ROUND & SQUARE HOUSING DIMENSIONS**

**TRIMMED / TRIMLESS**

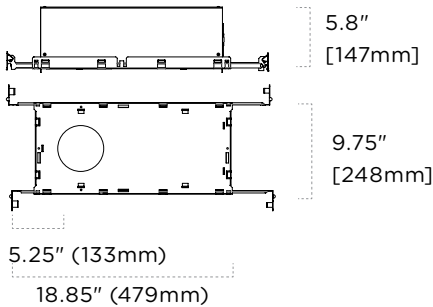

**ROUND WOOD TRIMLESS**

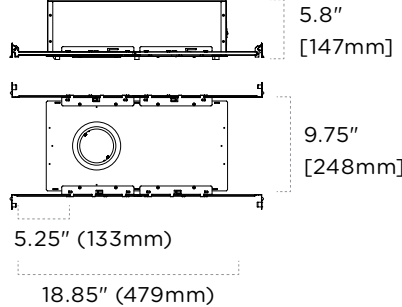

**SQUARE WOOD TRIMLESS**

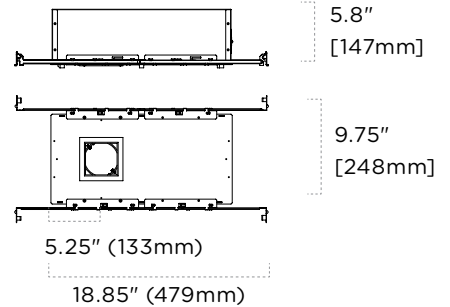

**CHICAGO PLENUM (CP) —ROUND & SQUARE HOUSING DIMENSIONS**

**TRIMMED / TRIMLESS**

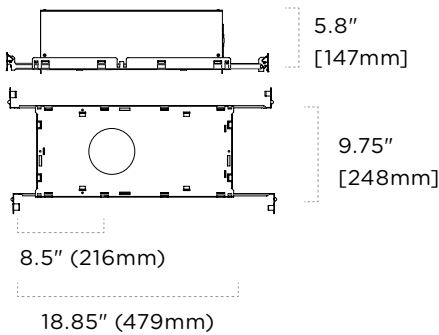

**ROUND WOOD TRIMLESS**

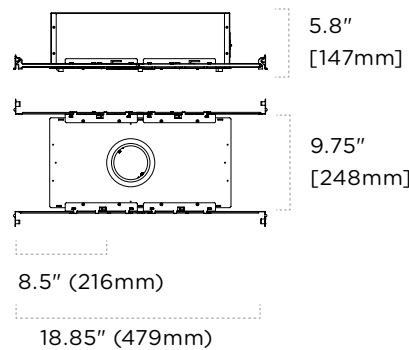

**SQUARE WOOD TRIMLESS**

