



# Legacy Downlights

2-167-T | Premium LED

## Starlite

The articulated Starlite tilts to precisely highlight focal points in a layered lighting design. Classic meets contemporary in this versatile, articulating trim. The Starlite is a machined aluminum trim which has been specifically designed to provide maximum flexibility to effectively light various environments.

### FEATURES

- Damp location listed
- Ø 2 5/8" [67mm] Aperture
- 30° vertical tilt
- Clear media standard
- Accepts up to 2 media
- Machined aluminum fixture
- Powder coated trim ring finishes
- Trim clips designed for 5/8" ceiling thickness
- Trimless version available (see separate specifications)

### LISTINGS



California  
Title 24 JA8

### DIMENSIONS—3 SERIES

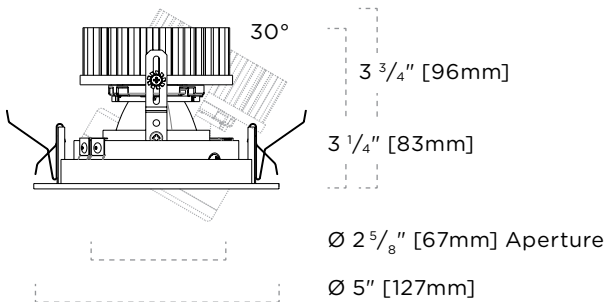

### DIMENSIONS—5, 7 & 9 SERIES

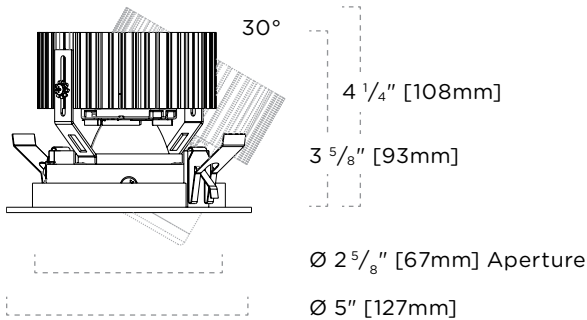

### PERFORMANCE SUMMARY

Color Accuracy (SDCM)	≤ 1 x 2	
L70 Estimate (h)	50,000	
Color Rendering (CRI)	83	98
Lumen Series	3	
Source Lumens	1000	700
LED Wattage	10	9
Lumen Series	5	
Source Lumens	1500	1000
LED Wattage	14	12
Lumen Series	7	
Source Lumens	2000	1300
LED Wattage	20	17
Lumen Series	9	
Source Lumens	2700	2100
LED Wattage	24	24
<b>California Title 24 Compliant</b>		

# Legacy Downlights

2-167-T | Premium LED

## Starlite



### TAG TYPE

--	--	--	--	--	--	--

### ORDER FORM

1	2	3	4	5	6	7

#### 1. TRIM

**2-167-T** Starlite

#### 2. FLANGE FINISH

- 01** White
- 04** Black
- 05** Matte Silver
- 06** Bronze
- 11** Matte Nickel
- CC** Custom Color<sup>1</sup>

#### 3. MODULE & BEAM SPREAD

- XTM28** 28° Beam
- XTM40** 40° Beam
- XTM60** 60° Beam

#### 4. COLOR TEMPERATURE

- 27** 2700K
- 30** 3000K
- 35** 3500K
- 40** 4000K
- BM27** Beauty 2700K<sup>2</sup>
- VB30** Vibrant 3000K

#### 5. CRI, LUMENS, SERIES

- 8310** 83 CRI, 1000lm, 3 Series
- 9807** 98 CRI, 700lm, 3 Series
- 8315** 83 CRI, 1500lm, 5 Series<sup>3</sup>
- 9810** 98 CRI, 1000lm, 5 Series<sup>3</sup>
- 8320** 83 CRI, 2000lm, 7 Series
- 9813** 98 CRI, 1300lm, 7 Series
- 8327** 83 CRI, 2700lm, 9 Series
- 9821** 98 CRI, 2100lm, 9 Series

#### 6. OPTIONAL MEDIA (2 MAXIMUM)

- CL** Clear
- EL** Elongating
- FRO** Frosted
- HC** Honeycomb
- PER** Perimeter Frosted
- SL** Solite Softening
- SPDL** Spread

#### 7. OPTIONS

- EXT** Extension Clips (Maximum 2")

#### NOTES

- 1** CC custom color requires consultation with Lightheaded sales personnel.
- 2** BM27 beauty color temperature is only available in 9807, 9810, 9813.
- 3** When selecting a housing, 5 series L, LE and LH dimming is not available in Title 24.

## SPECIFICATIONS

California Title 24 Compliant

### FLANGE FINISHES

- White
- Black
- Matte Silver
- Bronze
- Matte Nickel

### COLOR TEMPERATURES

- 2700K
- 2700K Beauty
- 3000K
- 3000K Vibrant
- 3500K
- 4000K

### BEAM SPREADS

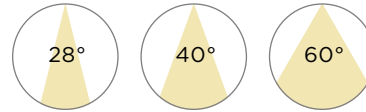

## PHOTOMETRIC DATA

### CONVERSION CHART

CRI	LUMENS	CCT / MULTIPLIER				TYPICAL SYSTEM POWER
		2700K	3000K	3500K	4000K	
83	1000	0.55				13W
	1500	0.75				17W
	2000	1 (Baseline)				23.5W
	2700	1.35				28W
98	700	0.40				12W
	1000	0.53				15W
	1300	0.65				22W
	2100	1.07				28W

### 7 SERIES, 40° BEAM, 3000K, 83 CRI, 2000 LUMENS

Report: L09130801

Trim Model: 2-167-T-01-SAS-XTM40-30-8320

Efficacy: 79lm/W

System Power: 23.5 W

Lumen: 1849lm

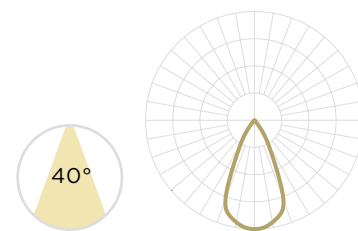

### OUTPUT

DISTANCE		BEAM DIAMETER		OUTPUT	
FT	M	FT	M	FC	LUX
6	1.8	5.1	1.55	76.2	820.5
8	2.4	6.8	2.07	42.9	461.6
10	3.0	8.5	2.59	27.4	295.4
12	3.7	10.2	3.11	19.1	205.1
14	4.3	11.9	3.63	14.0	150.7
16	4.9	13.6	4.15	10.7	115.4

**7 SERIES, 40° BEAM, 3000K, 83 CRI, 2000 LUMENS**

Report: L09130802  
 Trim Model: 2-167-T-01-SAS-XTM60-30-8320  
 Efficacy: 75lm/W  
 System Power: 23.5 W  
 Lumen: 1752lm

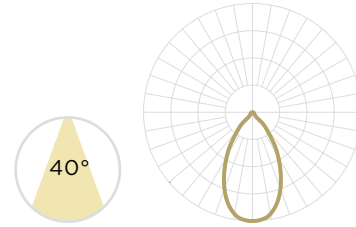

**OUTPUT**

DISTANCE		BEAM DIAMETER		OUTPUT	
FT	M	FT	M	FC	LUX
6	1.8	6.9	2.10	52.6	566.5
8	2.4	9.2	2.80	29.6	318.7
10	3.0	11.5	3.51	18.9	204.0
12	3.7	13.9	4.24	13.2	141.6
14	4.3	16.2	4.94	9.7	104.1
16	4.9	18.5	5.64	7.4	79.7

**COMPATIBLE HOUSINGS**

**NON-INSULATED/FRAME IN**

D4X-F-R  
 3, 5 Series  
 L 10.5" W 7.75" H 4.5"  
 L 267mm W 197mm H 115mm

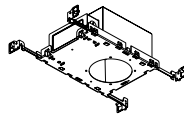

D4X-F-R  
 7, 9 Series  
 L 13.75" W 10.875" H 4.5"  
 L 350mm W 277mm H 115mm

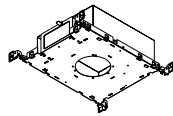

D4X-FD-R  
 3, 5 Series  
 L 10.5" W 7.75" H 5.5"  
 L 267mm W 197mm H 140mm

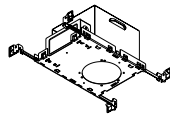

D4X-FD-R  
 7, 9 Series  
 L 13.75" W 10.875" H 5.5"  
 L 350mm W 277mm H 140mm

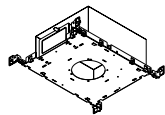

**INSULATED AIRTIGHT**

D4X-IC1A-R  
 3, 5 Series  
 L 22.5" W 8.5" H 5.875"  
 L 572mm W 216mm H 150mm

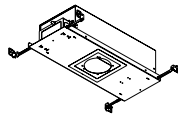

D4X-IC2A-R  
 3 Series  
 L 13.75" W 10.875" H 8.125"  
 L 350mm W 277mm H 207mm

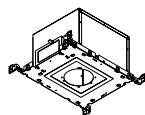

**NEW CONSTRUCTION PLATE**

R4P-F-R  
 3, 5, 7, 9 Series  
 L 6.5" W 6.375" H 1"  
 L 166mm W 162mm H 26mm

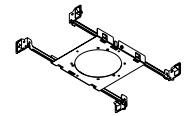

**REMODEL DRIVER**

DRX  
 3, 5, 7, 9 Series  
 L 8.25" W 3.25" H 2.75"  
 L 210mm W 83mm H 70mm

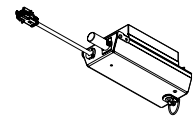

**CHICAGO PLENUM**

D4X-CP-R  
 3, 5 Series  
 L 13.75" W 10.875" H 4.5"  
 L 350mm W 277mm H 115mm

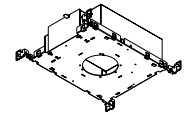

**EMERGENCY HOUSING**

D4X-FEM-R  
 3, 5, 7, 9 Series  
 L 13.75" W 10.875" H 4.5"  
 L 350mm W 277mm H 115m

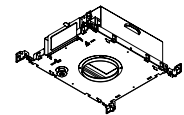

D4X-FDEM-R  
 3, 5, 7, 9 Series  
 L 13.75" W 10.875" H 5.5"  
 L 350mm W 277mm H 140mm

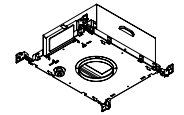

**CERTIFICATIONS**

