

Legacy Downlights

2-125-T | Premium LED

Deep Aurora

Deep Aurora provides an excellent cutoff where occupants require glare-free downlighting. The smaller lumen packages are highly effective in low mounting heights, while the larger packages supply efficient illumination from high ceilings.

FEATURES

- Damp location listed
- Ø 3 3/8" [86mm] Aperture
- 2 1/4" lamp regression above the ceiling plane for excellent glare control
- Clear media standard
- Accepts up to 2 media
- Die-cast aluminum fixture
- Powder coated and plated trim ring finishes
- Trim clips designed for 5/8" ceiling thickness
- Trimless version available (see separate specifications)

LISTINGS



California
Title 24 JA8

DIMENSIONS—3 SERIES

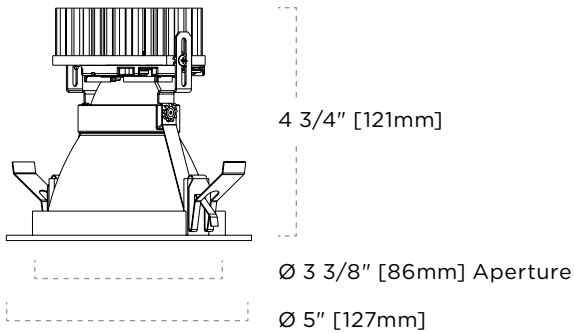

DIMENSIONS—5, 7 & 9 SERIES

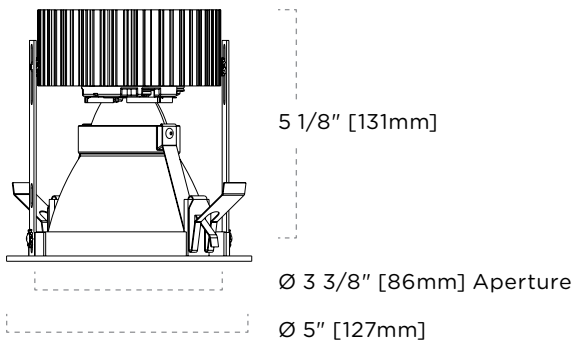

PERFORMANCE SUMMARY

Color Accuracy (SDCM)	≤ 1 x 2	
L70 Estimate (h)	50,000	
Color Rendering (CRI)	83	98
Lumen Series	3	
Source Lumens	1000	700
LED Wattage	10	9
Lumen Series	5	
Source Lumens	1500	1000
LED Wattage	14	12
Lumen Series	7	
Source Lumens	2000	1300
LED Wattage	20	17
Lumen Series	9	
Source Lumens	2700	2100
LED Wattage	24	24
California Title 24 Compliant		

Legacy Downlights

2-125-T | Premium LED

Deep Aurora

TAG TYPE



ORDER FORM

1	2	3	4	5	6	7	8

1. TRIM

2-125-T Deep Aurora

2. FLANGE FINISH

- 01** White
- 02** Chrome Plated
- 04** Black
- 05** Matte Silver
- 06** Bronze
- 11** Matte Nickel
- CC** Custom Color¹

3. REFLECTOR FINISH

- BLO** Black Open
- NICS** Nickel Satin
- SAS** Satin Silver
- WHO** White Open
- CC** Custom Color¹

4. MODULE & BEAM SPREAD

- XTM28** 28° Beam
- XTM40** 40° Beam
- XTM60** 60° Beam

5. COLOR TEMPERATURE

- 27** 2700K
- 30** 3000K
- 35** 3500K
- 40** 4000K
- BM27** Beauty 2700K²
- VB30** Vibrant 3000K

6. CRI, LUMENS, SERIES

- 8310** 83 CRI, 1000lm, 3 Series
- 9807** 98 CRI, 700lm, 3 Series
- 8315** 83 CRI, 1500lm, 5 Series
- 9810** 98 CRI, 1000lm, 5 Series³
- 8320** 83 CRI, 2000lm, 7 Series
- 9813** 98 CRI, 1300lm, 7 Series
- 8327** 83 CRI, 2700lm, 9 Series
- 9821** 98 CRI, 2100lm, 9 Series

7. OPTIONAL MEDIA (2 MAXIMUM)

- EL** Elongating
- FRO** Frosted
- HC** Honeycomb
- PER** Perimeter Frosted
- SL** Solite Softening
- SPDL** Spread
- CL** Clear

8. OPTIONS

- EXT** Extension Clips (Maximum 2")

NOTES

- 1** CC custom color requires consultation with Lightheaded sales personnel.
- 2** BM27 beauty color temperature is only available in 9807, 9810, 9813.
- 3** When selecting a housing, 5 series L, LE and LH dimming is not available in Title 24.

SPECIFICATIONS

California Title 24 Compliant

FLANGE FINISHES

-  White
-  Chrome Plated
-  Black
-  **Matte Silver**
-  Bronze
-  Gold Plated
-  Matte Nickel



REFLECTOR FINISHES

-  Black Open
-  Nickel Satin
-  Silver Satin
-  White Open

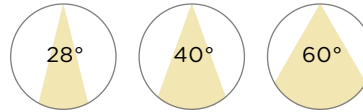
BEAM SPREADS



COLOR TEMPERATURES

-  **2700K**
-  **2700K Beauty**
-  **3000K**
-  **3000K Vibrant**
-  **3500K**
-  **4000K**

PHOTOMETRIC DATA

CONVERSION CHART

CRI	LUMENS	CCT / MULTIPLIER				TYPICAL SYSTEM POWER
		2700K	3000K	3500K	4000K	
83	1000	0.55				13W
	1500	0.75				17W
	2000	1 (Baseline)				23.5W
	2700	1.35				28W
98	700	0.40				12W
	1000	0.53				15W
	1300	0.65				22W
	2100	1.07				28W

7 SERIES, 40° BEAM, 3000K, 83 CRI, 2000 LUMENS

Report: L021501202

Trim Model: 2-120-T-01-SAS-XTM40-30-8320

Efficacy: 81lm/W

System Power: 23.4 W

Lumen: 1882lm

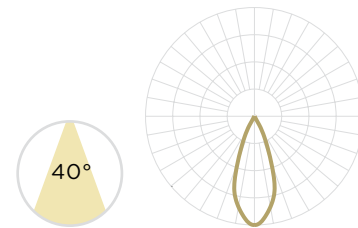

OUTPUT

DISTANCE		BEAM DIAMETER		OUTPUT	
FT	M	FT	M	FC	LUX
6	1.8	5.1	1.55	130.8	1407.4
8	2.4	6.8	2.07	73.5	791.7
10	3.0	8.5	2.59	47.1	506.7
12	3.7	10.2	3.11	32.7	351.8
14	4.3	11.9	3.63	24.0	258.5
16	4.9	13.6	4.15	18.4	197.9

7 SERIES, 60° BEAM, 3000K, 83 CRI, 2000 LUMENS

Report: L021501203
 Trim Model: 2-120-T-01-SAS-XTM60-30-8320
 Efficacy: 71lm/W
 System Power: 23.6 W
 Lumen: 1669lm

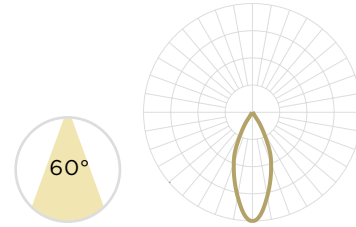

OUTPUT

DISTANCE		BEAM DIAMETER		OUTPUT	
FT	M	FT	M	FC	LUX
6	1.8	6.9	2.10	96.9	1042.9
8	2.4	9.2	2.80	54.5	586.6
10	3.0	11.5	3.51	34.9	375.4
12	3.7	13.9	4.24	24.2	260.7
14	4.3	16.2	4.94	17.8	191.6
16	4.9	18.5	5.64	13.6	146.7

COMPATIBLE HOUSINGS

NON-INSULATED/FRAME IN

D4X-FD-R
 3, 5 Series
 L 10.5" W 7.75" H 5.5"
 L 267mm W 197mm H 140mm

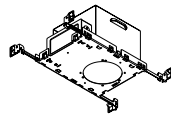

D4X-FD-R
 7, 9 Series
 L 13.75" W 10.875" H 5.5"
 L 350mm W 277mm H 140mm

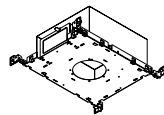

INSULATED AIRTIGHT

D4X-IC1A-R
 3, 5 Series
 L 22.5" W 8.5" H 5.875"
 L 572mm W 216mm H 150mm

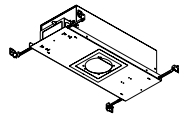

D4X-IC2A-R
 3 Series
 L 13.75" W 10.875" H 8.125"
 L 350mm W 277mm H 207mm

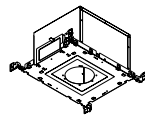

NEW CONSTRUCTION PLATE

R4P-F-R
 3, 5, 7, 9 Series
 L 6.5" W 6.375" H 1"
 L 166mm W 162mm H 26mm

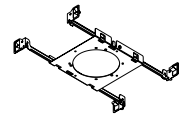

REMODEL DRIVER

DRX
 3, 5, 7, 9 Series
 L 8.25" W 3.25" H 2.75"
 L 210mm W 83mm H 70mm

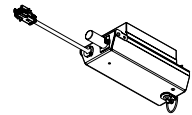

CHICAGO PLENUM

D4X-CP-R
 3, 5 Series
 L 13.75" W 10.875" H 4.5"
 L 350mm W 277mm H 115mm

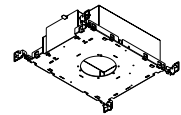

EMERGENCY HOUSING

D4X-FDEM-R
 3, 5, 7, 9 Series
 L 13.75" W 10.875" H 5.5"
 L 350mm W 277mm H 140mm

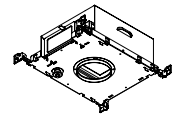

CERTIFICATIONS

