

Contortionist™

4-584-T | Premium LED

Square Pinhole

Our Contortionist™ series of hot adjustables twist & turn in ways you'll need to see to believe. These dual axis marvels of flexibility can tilt and rotate with minimal light cutoff - which means - you can aim light precisely where it's needed. Engineered as a three piece system, the trim, light engine, and housing configures to specific lighting needs.

FEATURES

Trim

- 2" [51mm] Aperture
- Die-cast aluminum trim
- Regressed aperture glass lens optional
- Damp location listed
- Wet location optional
- Trim clips designed for 5/8" [16mm] ceiling thicknesses
- Trimless version available (see separate specifications)

Light Engine

- Anodized black heat sink and media holder
- Media holder accepts up to 2 media
- Clear media standard, optional media available

Housings

- Rated for insulated. Non-insulated & Chicago plenum ceilings

PERFORMANCE SUMMARY—STANDARD DIMMING

Color Accuracy (SDCM)	≤ 1 x 2	
L70 Estimate (h)	50,000	
Color Rendering (CRI)	83	98
Lumen Series	3	
Source Lumens	1000	700
LED Wattage	10	9
Lumen Series	5	
Source Lumens	1500	1000
LED Wattage	14	12
Lumen Series	7	
Source Lumens	2000	1300
LED Wattage	20	17

LISTINGS



Wet
Location

DIMENSIONS—TRIM

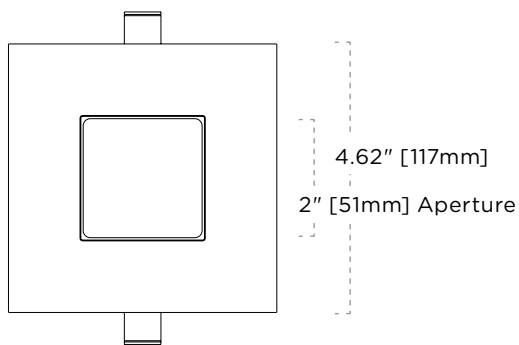
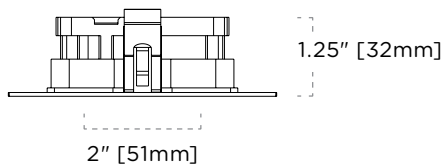

DIMENSIONS—LIGHT ENGINE

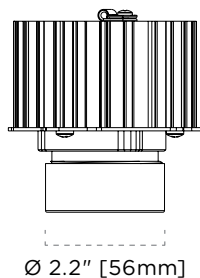

Square Pinhole

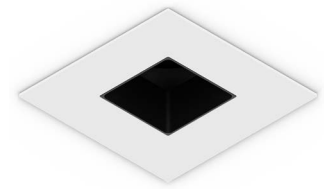

TAG TYPE



ORDER FORM

1	2	3	4	5	6	7	8

1. TRIM

4-584-T Square Pinhole Downlight

2. FLANGE FINISH

- 01** White
- 04** Black
- 05** Matte Silver
- 06** Bronze
- 11** Matte Nickel
- CC** Custom Color¹

3. GLASS

(MOUNTED TO TRIM)

- GFRO** Frosted²
- GSL** Solite Softening²
- OPEN** No Lens

4. MODULE & BEAM SPREAD

- 4-XTM28** 28° Beam
- 4-XTM40** 40° Beam
- 4-XTM60** 60° Beam

5. COLOR TEMPERATURE

- 27** 2700K
- 30** 3000K
- 35** 3500K
- 40** 4000K
- BM27** Beauty 2700K³
- VB30** Vibrant 3000K

6. CRI, LUMENS, SERIES

- 8310** 83 CRI, 1000lm, 3 Series
- 9807** 98 CRI, 700lm, 3 Series
- 8315** 83 CRI, 1500lm, 5 Series
- 9810** 98 CRI, 1000lm, 5 Series
- 8320** 83 CRI, 2000lm, 7 Series
- 9813** 98 CRI, 1300lm, 7 Series

7. OPTIONAL MEDIA (MOUNTED TO LIGHT ENGINE MAX. OF 2)⁴

- EL** Elongating
- FRO** Frosted
- HC** Honeycomb
- PER** Perimeter Frosted
- SL** Softening

8. OPTIONS







- EXT** Extensions Clips (Maximum 2")

NOTES

- 1** CC custom color requires factory consultation.
- 2** GFRO & GSL glass lens options are attached to the regressed trim aperture giving the trim a wet location listing.
- 3** BM27 beauty color temperature is only available in 98 CRI.
- 4** Optional media is installed in the light engine media holder & replaces clear media when selected.

SPECIFICATIONS

COLOR TEMPERATURES

-  2700K
-  2700K Beauty
-  3000K
-  3000K Vibrant
-  3500K
-  4000K

FLANGE FINISHES

-  White
-  Black
-  Matte Silver
-  Bronze
-  Matte Nickel

BEAM SPREADS

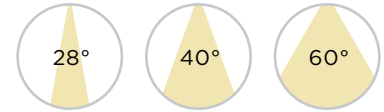

COMPATIBLE HOUSINGS

NON-INSULATED/FRAME IN

L4X-F-SF (Square Fixed)
3, 5, 7 Series
L 13.75" W 9.75" H 5.5"
L 350mm W 248mm H 140mm

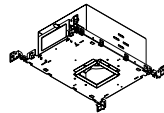

INSULATED AIRTIGHT

L4X-IC1A-SF (Square Fixed)
3, 5 Series
L 21.125" W 9.75" H 5.75"
L 537mm W 248mm H 146mm

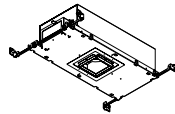

CHICAGO PLENUM

L4X-CP-SF (Square Fixed)
3, 5 Series
L 13.625" W 10.875" H 5.5"
L 346mm W 276mm H 140mm

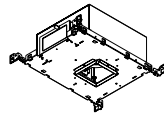

NON-INSULATED EMERGENCY

L4X-FEM-SF (Square Fixed)
3, 5, 7 Series
L 13.75" W 10.875" H 5.5"
L 350mm W 277mm H 140mm

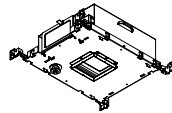

CERTIFICATIONS

