

# Install Guide

## 511-050/072 PUCK LIGHT SERIES

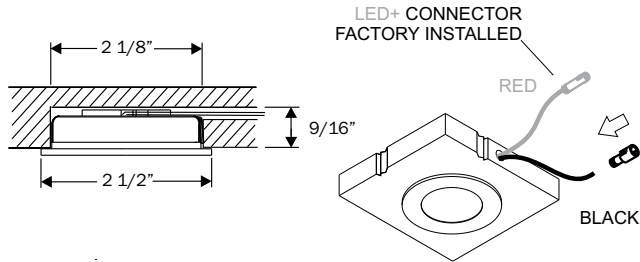

**511 050**  
**Recessed Mount**

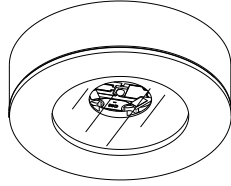
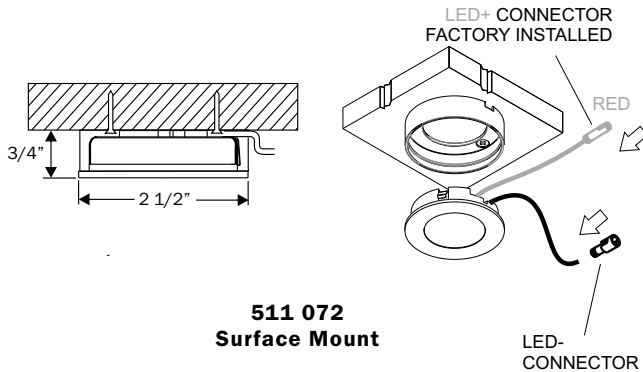

**511 072**  
**Surface Mount**

**Caution:** Ensure Driver is switched **OFF** before connecting LED. Failure to do so will cause **IMMEDIATE LED FAILURE**.

Wiring must be connected as noted in diagrams below. Failure to follow instruction provided will result in damage to luminaire.

**CAUTION TO INSTALLER:**

- ◆ This LED device is polarity sensitive and must be wired in series.
- ◆ LED- connector to be attached after fixture installation
- ◆ LED+ connector (RED) is factory installed
- ◆ Approved for blind hole applications (Router fit)
- ◆ Certified as stand alone luminaire
- ◆ For use with approved LED Drivers, refer to Lightheaded LED driver specification sheets for compatibility and dimming

**D1CH-DIM-120/277 LED DRIVER SUPPORTS ONE TO ELEVEN (1-11) 511 SERIES LED ONLY**

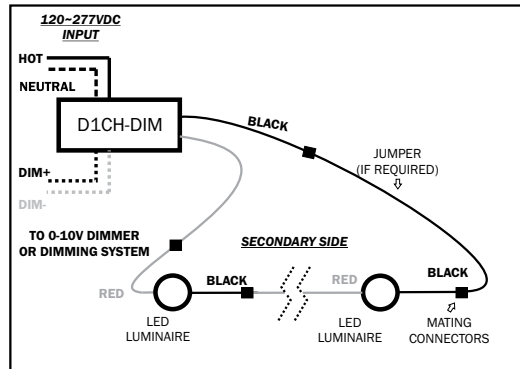

**D10W-DIM-120 LED DRIVER SUPPORTS TWO TO NINE (2-9) 511 SERIES LED ONLY**

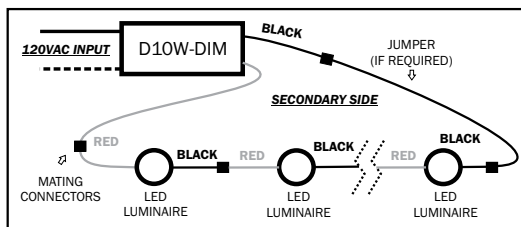

**D15W-DIM-120 LED DRIVER SUPPORTS NINE TO THIRTEEN (9-13) 511 SERIES LED ONLY**

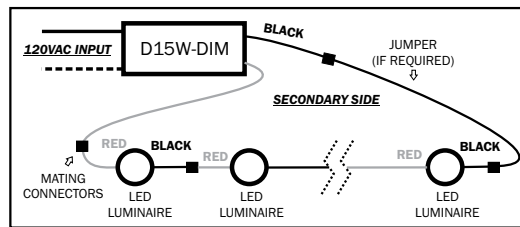

# Install Guide

## 511-050/072 PUCK LIGHT SERIES

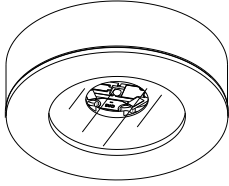

**D2CH-DIM-120/277 2 Channel LED DRIVER SUPPORTS ONE TO SIXTEEN (1-16 per Channel)**  
511 SERIES LED ONLY

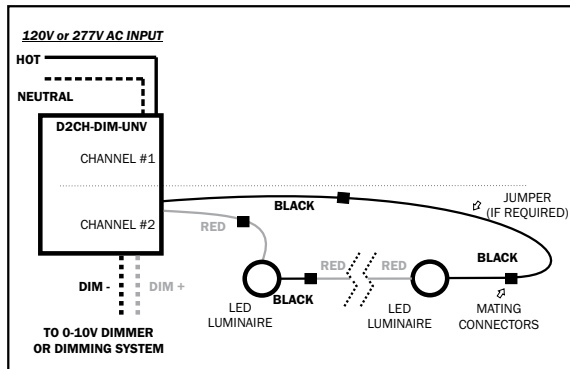

**D4CH-DIM-120/277 4 Channel LED DRIVER SUPPORTS TWO TO SIXTEEN (2-16 per Channel)**  
511 SERIES LED ONLY

