

Install Guide

PMX SERIES PENDANT MOUNTED MATRIX SP1 STYLE

This product must be installed in accordance with the applicable code by a person familiar with the construction and operation of the product and the hazards involved. Read all of these instructions before installing.

WARNING: Disconnect power prior to servicing or installing.

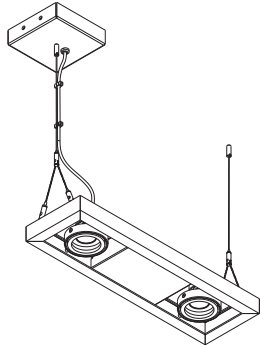

1

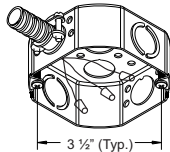

Install an Iberville 1 1/2" deep octagon box (part # CI-54151-1/2) or equivalent. Center octagon box in position for best fixture position.

2

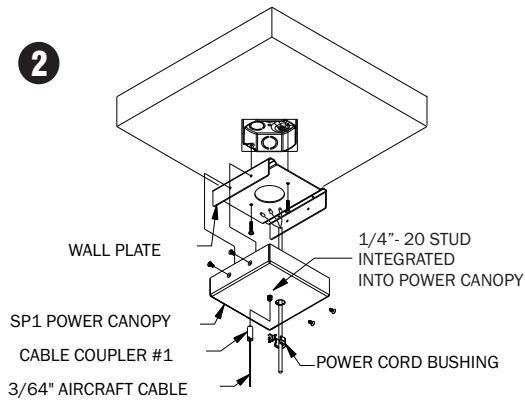

Install wall plate, make electrical connection from power cord supplied with PMX fixture. Install power cord bushing. Mount power canopy with 4 set CSK screws provided. Install cable coupler #1 into power canopy stud.

3

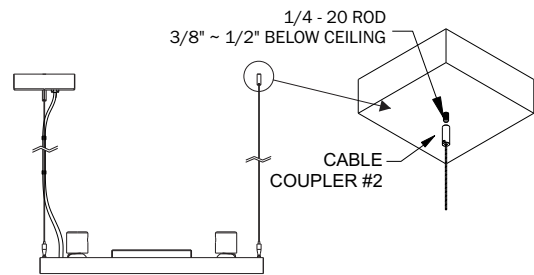

Positioning of Cable Coupler #2 will be determined by the length of the PMX fixture being installed.

1/4" - 20 rod must be secured or anchored in ceiling system. (rod or anchoring to be supplied by others). Proper installation of the rod length should protrude through the ceiling approximately 3/8" to 1/2"

Once installed and secured, cable coupler #2 can now be screwed into the rod.

4

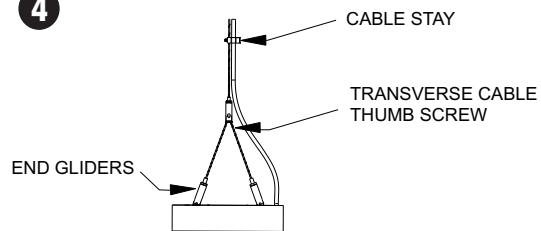

To ensure the PMX fixture is horizontally balanced, adjust transverse cable by loosen transverse cable thumb screw. Addition cable available at the end gliders.

Adjust power cord tension by loosen thumb screw of cable stable.



Install Guide

PMX SERIES PENDANT MOUNTED MATRIX SP2 STYLE

This product must be installed in accordance with the applicable code by a person familiar with the construction and operation of the product and the hazards involved. Read all of these instructions before installing.

WARNING: Disconnect power prior to servicing or installing.

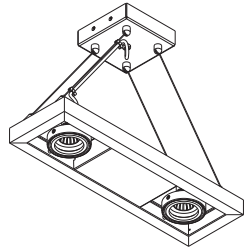

1

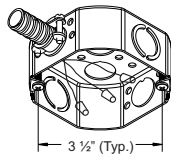

Install an Iberville 1 1/2" deep octagon box (part # CI-54151-1/2) or equivalent. Center octagon box in position for best fixture position.

2

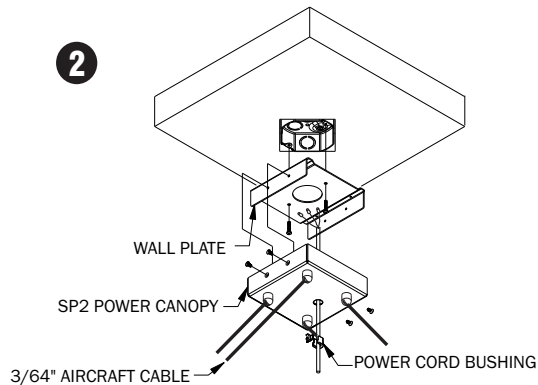

Install wall plate, make electrical connection from power cord supplied with PMX fixture. Install power cord bushing. Mount power canopy with 4 set CSK screws provided.

3

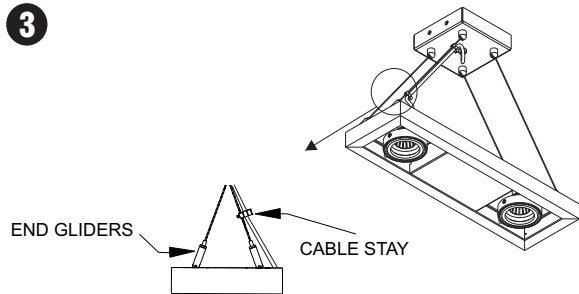

To adjust length of aircraft cable and horizontal balance of fixture, adjust all four end gliders individually. additional cable available at the end glider.

Adjust power cord tension by loosen thumb screw of cable stable.



Install Guide

PMX LARGE SERIES

CDMR 111

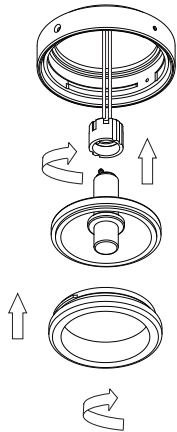

Twist lamp into GX 8.5 socket accordingly. Line up tabs on front ring to base ring, turn clockwise to secure into place.

AR 111

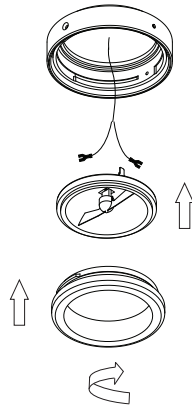

Attach AR111 lamp into socket provided. Line up tabs on front ring to base ring, turn clockwise to secure into place.

PAR 36

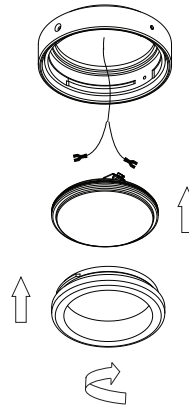

Attach PAR36 lamp into socket provided. Line up tabs on front ring to base ring, turn clockwise to secure into place.

PAR 30 CMH

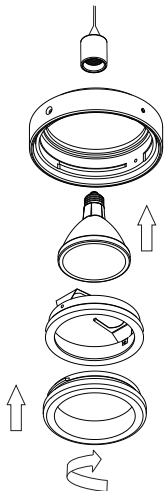

Twist lamp into medium base socket. Place lamp between clips on adaptor ring. Line up tabs on front ring to base ring, turn clockwise to secure into place.

PAR 30 Halogen

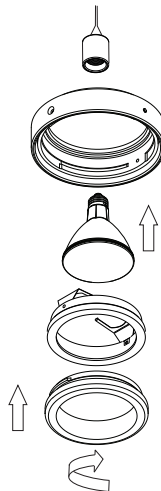

Twist lamp into medium base socket. Place lamp between clips on adaptor ring. Line up tabs on front ring to base ring, turn clockwise to secure into place.

Glass Lens Option

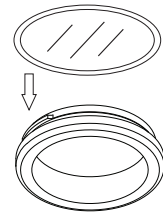

To Install an optional glass lens, twist counter-clockwise to release front ring, turn ring until tabs line up & ring drops out. Install glass lens into face ring, use snap ring to hold glass in position.
(Glass Lens & Snap ring ordered separately)



Install Guide

PMX SMALL SERIES

MR16

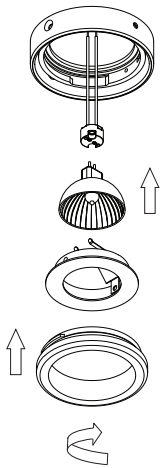

Push MR16 lamp into GU 5.3 (MR16) Socket accordingly. Place MR16 lamp into adapter ring. Line up tabs on front ring to base ring, turn clockwise to secure into place.

GX10 CMH

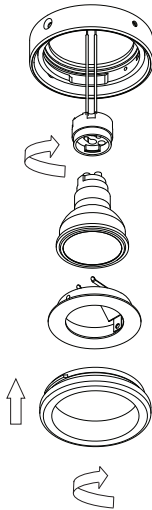

Twist GX10 MR16 CMH lamp into GX10 Socket accordingly. Line up tabs on front ring to base ring, turn clockwise to secure into place.

AR70

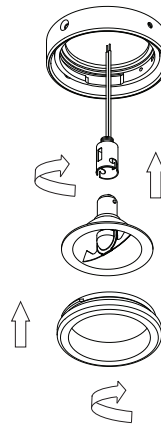

Twist AR70 Lamp into DC Bayonet base Socket provided. Line up tabs on front ring to base ring, turn clockwise to secure into place.

PAR20 CMH

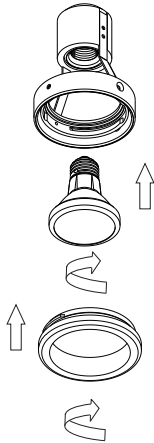

Twist lamp into medium base pulse rated Socket. Line up tabs on front ring to base ring, turn clockwise to secure into place.

PAR 20

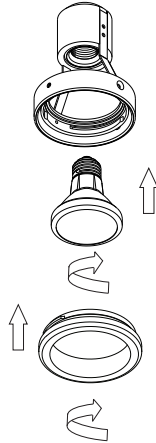

Twist lamp into medium base Socket. Line up tabs on front ring to base ring, turn clockwise to secure into place.

XIC LED

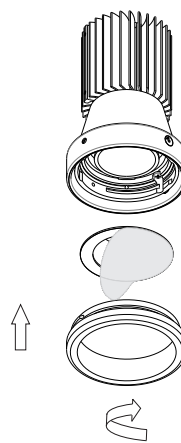

Release lamp holder from assembly, remove green protective film over adapter. Line up tabs on front ring to base ring, turn clockwise to secure into place.

Glass Lens Option

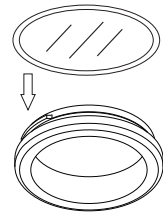

To Install an optional glass lens, twist counter-clockwise to release front ring, turn ring until tabs line up & ring drops out. Install glass lens into face ring, use snap ring to hold glass in position.
(Glass Lens & Snap ring ordered separately)



Install Guide

XIC STANDARD (ELV) DIMMING INSTRUCTION

WARNING:

ENSURE FIXTURE IS SWITCHED **OFF** BEFORE CONNECTING LED PRODUCT.
FAILURE TO DO SO WILL CAUSE **IMMEDIATE LED FAILURE**

